

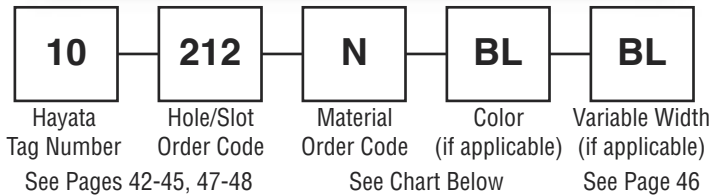

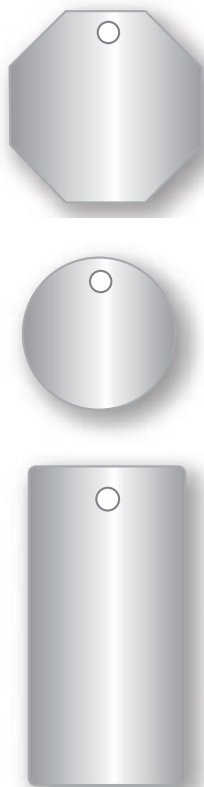







How to Order Your Hayata Blank Tags



Which Tags for your embossing unit?

- - SmartTag™ 4500 & 2500 compatible
- - SmartTag™ 1100 compatible
- - HAY-40B compatible
- - MobileTag™ 600 compatible



Tag Material Metal Options	Thickness (in)	Order Code	Anodized Colors	
Mill Finished Aluminum (3003)	.010	A		
Mill Finished Aluminum (3003)	.016	B		
Mill Finished Aluminum (3003)	.025	C	Red = RD	Green = GR
Tin Plate Steel #25 Matte	.015	D		
Galvanized Steel Soft Temper	.015	E	Blue = BL	Light Blue = LB
Brass (260 Cartridge Brass)	.016	F		
Stainless Steel (304 Dull)	.012	G	Violet = VT	Yellow = YL
Stainless Steel (304 Dull)	.014	H		
Stainless Steel (304 Dull)	.015	I	Orange = OR	Brown = BR
Stainless Steel (304 Dull)	.020	R		
Stainless Steel (304 Bright)	.015	J	Clear = CL	Black = BK
Stainless Steel (316 Dull)	.015	K		
Stainless Steel (316 Dull)	.030	S		
Stainless Steel (430 Bright)	.015	L		
Stainless Steel (Painted Black 1-side)	.015	M		
Anodized Aluminum (5005)	.016	N	RD, GR, BL, LB, YL, OR, BR, BK, CL	
Anodized Aluminum (5005)	.032	O	RD, GR, BL, VT, YL, OR, BK	
Anodized Aluminum (5205)	.016	P	BK Only	
Anodized Aluminum (5005)	.025	Q	Call for Color Options	

T-Series Easy Entry™ 316 Stainless Steel Tags

Hayata Easy Entry™ tags are made with a raised area on both sides to allow for easy insertion of stainless steel cable ties, thus allowing the tag to sit flush against a cable or pipe.

Workers appreciate how much faster the tags can be installed with the Easy Entry feature.

The T8919 and T5119 are designed to work with the SmartTag™ 4500 which can produce 450+ embossed one-line tags per hour or more than 180 three-line tags per hour.



Raised area allows tie to sit flush against the tag.



Max. No. of Lines: 3 Max No. of Characters Per Line: 11
●●● Material: 316 Stainless Steel

NEW

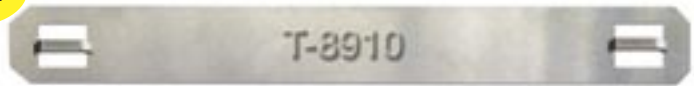

Max. No. of Lines: 1 Max No. of Characters Per Line: 23
●● Material: 316 Stainless Steel



Max. No. of Lines: 3 Max No. of Characters Per Line: 23
●●● Works with SmartTag™ 4500 & 1100

Hayata Part No.	Length		Width		Thickness	
	In	mm	In	mm	In	mm
T-5119	2.00	51	0.75	19	0.015	0.26
T-8910	3.50	89	0.39	10	0.015	0.26
T-8919	3.50	89	0.75	19	0.015	0.26
Material: 316 Stainless Steel						

NOTE: Characters Per Line are based on a 4mm Font Size.

What Other Tags Work With Hayata's SmartTag Machines?

Look for these tag page icons:

- - SmartTag™ 4500 & 2500 compatible
- - SmartTag™ 1100 compatible
- - HAY-40B compatible
- - MobileTag™ 600 compatible

Information for maximum number of lines and characters is identified with each eligible tag.

NOTE: Characters Per Line are based on a 4mm Font Size.

Rectangular Single Tags

TAG 11



● Max. No. of Lines: 2 Max No. of Characters Per Line: 19

Order Code	# of Holes/Slots	Hole Size	Slot Size
000	0	-	-
112	1	.125"	-
212	2	.125"	-
4RL	4	-	.062" x .400"

●● Material Options: B, C, D, E, F, I, J, K, L, M, N, O, Q

TAG 12



● Max. No. of Lines: 3 Max No. of Characters Per Line: 22

Order Code	# of Holes	Hole Size	Slot Size
000	0	-	-
112	1	.125"	-
212	2	.125"	-

●● Material Options: B, C, D, E, F, I, J, K, L, M, N, O

TAG 13



Order Code	# of Holes	Hole Size	Slot Size
000	0	-	-
112	1	.125"	-
128	1	.281"	-

●● Material Options: B, C, F, H, I, J, K, L, N, O, Q

TAG 14



● Max. No. of Lines: 4 Max No. of Characters Per Line: 27

Order Code	# of Holes	Hole Size	Slot Size
125	1	.250"	-

●●● Material Options: I, J, K, L

TAG 15



● Max. No. of Lines: 4 Max No. of Characters Per Line: 14

Order Code	# of Holes	Hole Size	Slot Size
000	0	-	-
121	1	.218"	-
115	1	.156"	-
215	2	.156"	-

●●● Material Options: B, C, F, H, I, J, K, L, N, O, Q

TAG 16

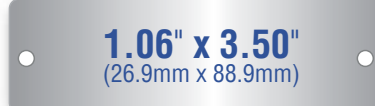

● Max. No. of Lines: 4 Max No. of Characters Per Line: 27

Order Code	# of Holes/Slots	Hole Size	Slot Size
000	0	-	-
115	1	.156"	-
125	1	.250"	-
137	1	.375"	-
215	2	.156"	-
225	2	.250"	-
420	4	.200"	-
4RL	4	-	.062" x .400"

●●● Material Options: B, C, D, E, F, I, J, K, L, M, N, O, Q

TAG 17



● Max. No. of Lines: 4 Max No. of Characters Per Line: 15

Order Code	# of Holes	Hole Size	Slot Size
000	0	-	-
112	1	.125"	-
125	1	.250"	-
212	2	.125"	-
425	4	.250"	-

●●● Material Options: B, C, F, H, I, J, N, O, Q

TAG 18



● Max. No. of Lines: 4 Max No. of Characters Per Line: 14

Order Code	# of Holes	Hole Size	Slot Size
000	0	-	-
112	1	.125"	-
125	1	.250"	-
212	2	.125"	-

●●● Material Options: B, C, F, H, I, J, K, L, N, O, Q

NOTE: Characters Per Line are based on a 4mm Font Size.

- - SmartTag™ 4500 & 2500 compatible
- - SmartTag™ 1100 compatible
- - HAY-40B compatible
- - MobileTag™ 600 compatible

See page 42 for Material Options description

Rectangular Single Tags

(Continued)

Military Dog Tag

(Rolled Edge)

1.12" x 2.00"
(28.5mm x 50.8mm)
- Rolled Edge -



TAG 19

● Max. No. of Lines: 4 Max No. of Characters Per Line: 14

Order Code	# of Holes/Slots	Hole Size	Slot Size
000	0	-	-
114	1	.140"	-
214	2	.140"	-
2RL	2	-	.062" x .400"

●●● Material Options: F,H,K,L

1.53" x 2.69"
(38.9mm x 68.3mm)

TAG 22

● Max. No. of Lines: 7 Max No. of Characters Per Line: 21

Order Code	# of Holes	Hole Size	Slot Size
000	0	-	-
112	1	.125"	-
156	1	.156"	-
212	2	.125"	-
215	2	.156"	-

●●● Material Options: B,C,D,E,F,I,J,K,L,M,N,O,Q

Medical Alert Tag

1.25" x 2.25"
(31.7mm x 57mm)



TAG 10

● Max. No. of Lines: 5 Max No. of Characters Per Line: 15

Order Code	# of Holes	Hole Size	Slot Size
000	0	-	-
114	1	.140"	-
215	2	.156"	-
425	4	.250"	-

●●● Material Options: B, C, F, H, I, J, N, O, Q

1.56" x 3.50"
(39.6mm x 88.9mm)

TAG 23

● Max. No. of Lines: 7 Max No. of Characters Per Line: 26

Order Code	# of Holes/Slots	Hole Size	Slot Size
000	0	-	-
112	1	.125"	-
115	1	.156"	-
125	1	.250"	-
137	1	.375"	-
212	2	.125"	-
215	2	.156"	-
225	2	.250"	-
1LG	1	-	.125" x .500"
4RL	4	-	.062" x .400"

●●● Material Options: B,C,D,E,H,I,J,K,L,M,N,O,Q

1.37" x 3.75"
(34.8mm x 95.3mm)

TAG 20

● Max. No. of Lines: 6 Max No. of Characters Per Line: 29

Order Code	# of Holes	Hole Size	Slot Size
000	0	-	-
121	1	.218"	-
221	2	.218"	-

●●● Material Options: 0

1.57" x 3.15"
(39.9mm x 80mm)

TAG 24

● Max. No. of Lines: 7 Max No. of Characters Per Line: 24

Order Code	# of Holes	Hole Size	Slot Size
000	0	-	-
115	1	.156"	-
215	2	.156"	-

●●● Material Options: B,C,D,E,F,I,J,K,L,M,N,O,Q

1.45" x 1.29"
(36.8mm x 32.8mm)

TAG 21

Order Code	# of Holes	Hole Size	Slot Size
000	0	-	-
122	1	.220"	-

●●● Material Options: B,C,F,H,I,J,K,L,N,O,Q

NOTE:

Characters Per Line are based on a 4mm Font Size.

- - SmartTag™ 4500 & 2500 compatible
 - - SmartTag™ 1100 compatible
 - - HAY-40B compatible
 - - MobileTag™ 600 compatible
- See page 42 for Material Options description

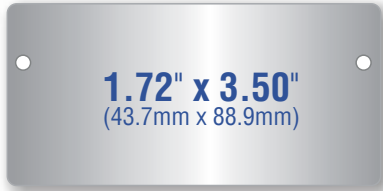

TAG

25

● Max. No. of Lines: 8 Max No. of Characters Per Line: 25

Order Code	# of Holes	Hole Size	Slot Size
000	0	-	-
115	1	.156"	-
118	1	.188"	-
215	2	.156"	-
218	2	.188"	-

●●● Material Options: B,C,D,E,F,I,J,K,L,M,N,O,Q

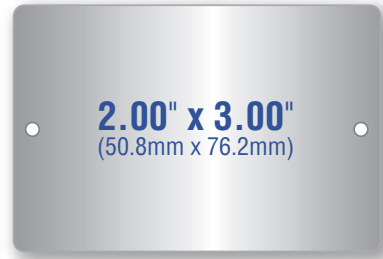

TAG

28

● Max. No. of Lines: 9 Max No. of Characters Per Line: 22

Order Code	# of Holes/Slots	Hole Size	Slot Size
000	0	-	-
112	1	.125"	-
212	2	.125"	-
HLG	1	-	.125" x .500"

●●● Material Options: B,C,D,E,F,I,J,K,L,M,N,O,Q Luggage Slot

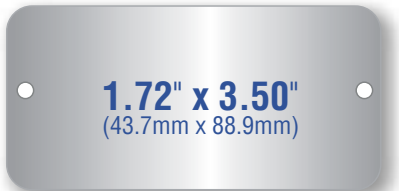

TAG

26

● Max. No. of Lines: 8 Max No. of Characters Per Line: 25

Order Code	# of Holes/Slots	Hole Size	Slot Size
000	0	-	-
109	1	.093"	-
115	1	.156"	-
118	1	.188"	-
125	1	.250"	-
128	1	.281"	-
150	1	.500"	-
209	2	.093"	-
215	2	.156"	-
221	2	.216"	-
225	2	.250"	-
420	4	.200"	-
425	4	.250"	-
2TN	2	-	.188" x .063"

●●● Material Options: B,C,D,E,F,I,J,K,L,M,N,O



TAG

50

● Max. No. of Lines: 1 Max No. of Characters Per Line: 15

Order Code	# of Slots	Hole Size	Slot Size
000	0	-	-
1SL	1	-	.039" x .33"

●●● Material Options: B,I,J,K



TAG

51

● Max. No. of Lines: 2 Max No. of Characters Per Line: 15

Order Code	# of Slots	Hole Size	Slot Size
000	0	-	-
2SL	2	-	.059" x .334"

●●● Material Options: B,I,J,K



TAG

52

● Max. No. of Lines: 3 Max No. of Characters Per Line: 20

Order Code	# of Holes	Hole Size	Slot Size
000	0	-	-
123	1	.236"	-

●●● Material Options: B,I,J,K



TAG

27

● Max. No. of Lines: 9 Max No. of Characters Per Line: 15

Order Code	# of Holes	Hole Size	Slot Size
000	0	-	-
115	1	.156"	-

●●● Material Options: B,C,F,H,I,J,K,L,N,O,Q



TAG

53

● Max. No. of Lines: 2 Max No. of Characters Per Line: 18

Order Code	# of Slots	Hole Size	Slot Size
000	0	-	-
4RL	4	-	.078" x .354"

●●● Material Options: B,I,J,K

Rectangular Single Tags

(Continued)

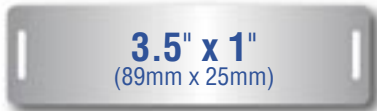

TAG 54

● Max. No. of Lines: 2 Max No. of Characters Per Line: 15

Order Code	# of Slots	Hole Size	Slot Size
000	0	-	-
2VSL	2	.078"	.118" x .470"
2VSL2-R	2		.56" x .099"

●●● Material Options: I, R



TAG 55

● Max. No. of Lines: 2 Max No. of Characters Per Line: 15

Order Code	# of Holes	Hole Size	Slot Size
000	0	-	-
120-R	4	.130"	-

●●● Material Options: B, I, J, K



TAG 29

● Max. No. of Lines: 10 Max No. of Characters Per Line: 24

Order Code	# of Holes/Slots	Hole Size	Slot Size
000	0	-	-
115	1	.156"	-
118	1	.188" (corner)	-
120	1	.203" (corner)	-
125	1	.250" (centered)	-
137	1	.375" (centered)	-
150	1	.500"	-
215	2	.156"	-
225	2	.250"	-
415	4	.156"	-
1LG	1	-	.125" x .500"
2TN	2	-	.188" x .063"

●●● Material Options: B, C, D, E, F, I, J, K, L, M, N, O, Q



TAG 30

● Max. No. of Lines: 12 Max No. of Characters Per Line: 26

Order Code	# of Holes	Hole Size	Slot Size
000	0	-	-
115	1	.156"	-
125	1	.250"	-
215	2	.156"	-
225	2	.250"	-
415	4	.156"	-

●● Material Options: B, C, D, E, F, K, L, M, N, O, Q



TAG 31

● Max. No. of Lines: 13 Max No. of Characters Per Line: 33

Order Code	# of Holes	Hole Size	Slot Size
000	0	-	-
115	1	.156"	-
118	1	.188" *	-
215	2	.156"	-
415	4	.156"	-

●● Material Options: B, C, D, E, F, I, J, K, L, M, N, O, Q

* Centered on 4" Sides

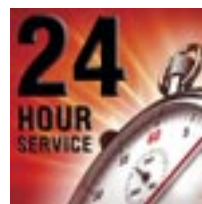

- - SmartTag™ 4500 & 2500 compatible
 - - SmartTag™ 1100 compatible
 - - HAY-40B compatible
 - - MobileTag™ 600 compatible
- See page 42 for Material Options description

NOTE: Characters Per Line are based on a 4mm Font Size.

Rectangular Single Tags

(Continued)

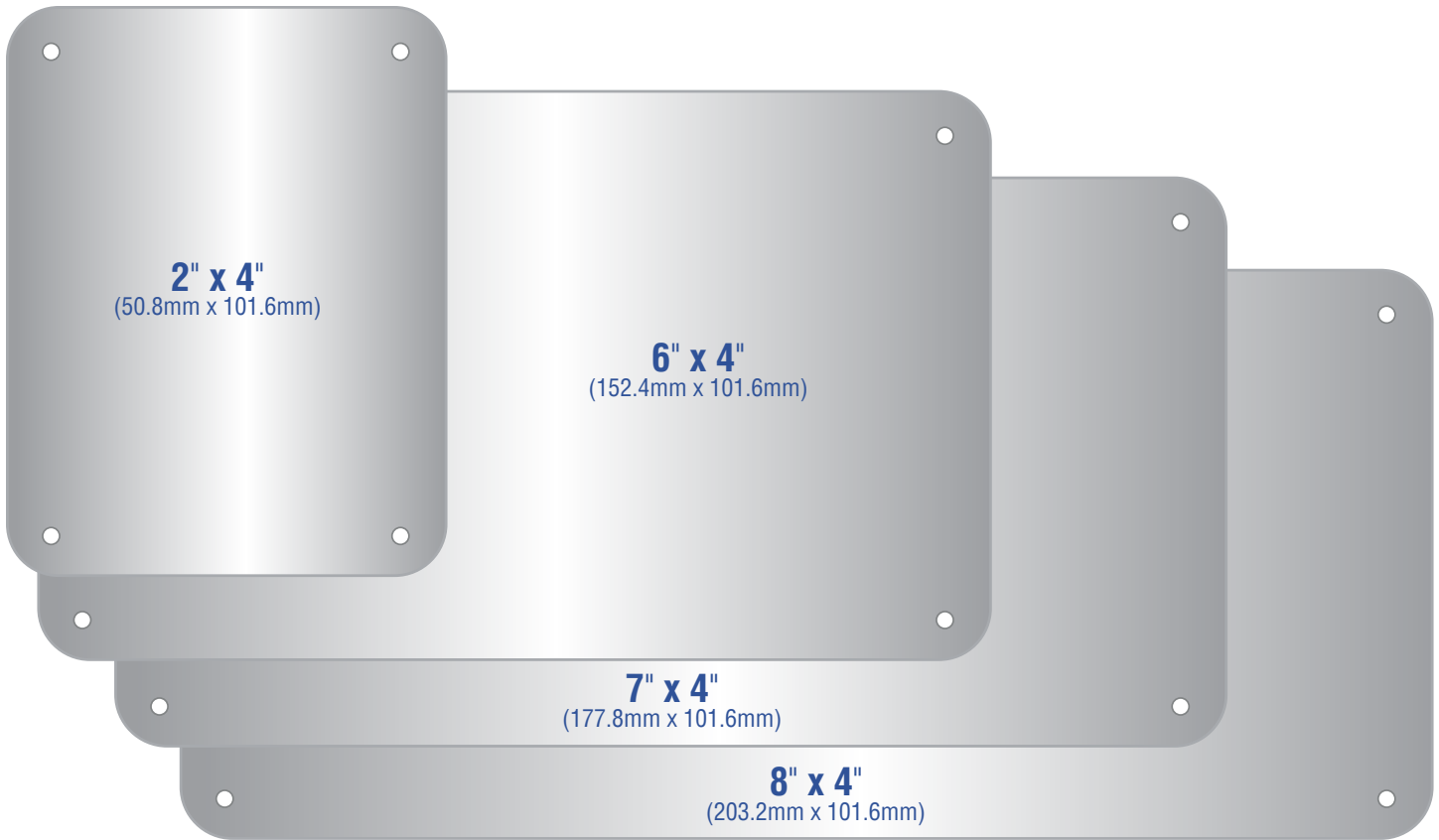

TAG 60 **2" x 4"**
(50.8mm x 101.6mm)
● Max. No. of Lines: 2 Max No. of Characters Per Line: 15

Order Code	# of Holes	Hole Size	Slot Size
000	0	-	-
415	4	.156"	-

●●● Material Options: B, I, J, K

TAG 61 **6" x 4"**
(152.4mm x 101.6mm)
● Max. No. of Lines: 2 Max No. of Characters Per Line: 15

Order Code	# of Holes	Hole Size	Slot Size
000	0	-	-
415	4	.156"	-

● Material Options: B, I, J, K

TAG 62 **7" x 4"**
(177.8mm x 101.6mm)
● Max. No. of Lines: 2 Max No. of Characters Per Line: 15

Order Code	# of Holes	Hole Size	Slot Size
000	0	-	-
415	4	.156"	-

● Material Options: B, I, J, K

TAG 63 **8" x 4"**
(203.2mm x 101.6mm)
● Max. No. of Lines: 2 Max No. of Characters Per Line: 15

Order Code	# of Holes	Hole Size	Slot Size
000	0	-	-
415	4	.156"	-

● Material Options: B, I, J, K

Variable-Width Combo Tags

NOTE: Tags 32, 33 and 34 are NOT available for 24 Hour Embossing Service

**TAG
32**



.75" up to 12" Wide
(19mm up to 304.8mm Wide)

Order Code	# of Slots	Hole Size	Slot Size
000	0	-	-
IRL	1	-	.062" x .400"

● Material Options: A,G,I

**TAG
33**



1.25" up to 6" Wide
(31.75mm up to 152.4mm Wide)

Order Code	# of Holes	Hole Size	Slot Size
000	0	-	-
114	1	.140"	-
215	2	.156"	-
425	4	.250"	-

● Material Options: P

**TAG
34**



2.12" up to 6" Wide
(53.8mm up to 152.4mm Wide)

Order Code	# of Holes/Slots	Hole Size	Slot Size
000	0	-	-
115	1	.156"	-
215	2	.156"	-
4RL	4	-	.062" x .400"
119	1	.198"	-
219	2	.198"	-

● Material Options: B,C,F,N



Aluminum Strapping Roll

Milled-finish aluminum for use in slotted tag installation.

Hayata Part # ALBAND-B-85
.016" x .3125" x 85'

20 Rolls per Case

Rectangular Combo Tags

1.72" x 3.50"
(43.7mm x 88.9mm)

Overall Tag Size

Two (2) Finished Tags

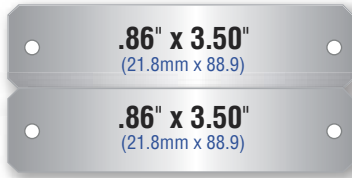

TAG

35

● Max. No. of Lines/Tag: 3 Max No. of Characters Per Line: 19

Order Code	# of Holes/Slots	Hole Size	Slot Size
000	0	-	-
115	1	.156"	-
215	2	.156"	-
4RL	4	-	.062" x .400"

●●● Material Options: B, C, F, N, O

2.12" x 3.37"
(53.8mm x 85.6mm)

Overall Tag Size

Two (2) Finished Tags



TAG

36

● Max. No. of Lines/Tag: 4 Max No. of Characters Per Line: 19

Order Code	# of Holes/Slots	Hole Size	Slot Size
000	0	-	-
115	1	.156"	-
125	1	.250"	-
215	2	.156"	-
225	2	.250"	-
4RL	4	-	.062" x .400"

●●●● Material Options: B, C, F, N, O

2.12" x 3.37"
(53.8mm x 85.6mm)

Overall Tag Size

Three (3) Finished Tags



TAG

37

● Max. No. of Lines/Tag: 2 Max No. of Characters Per Line: 18

Order Code	# of Holes/Slots	Hole Size	Slot Size
000	0	-	-
115	1	.156"	-
215	2	.156"	-
4RL	4	-	.078" x .354"

●●●● Material Options: B, C, F, N, O

2.12" x 3.37"
(53.8mm x 85.6mm)

Overall Tag Size

Four (4) Finished Tags

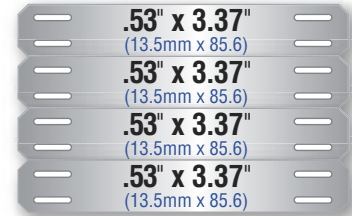

TAG

38

● Max. No. of Lines/Tag: 1 Max No. of Characters Per Line: 18

Order Code	# of Holes/Slots	Hole Size	Slot Size
000	0	-	-
115	1	.156"	-
119	1	.198"	-
215	2	.156"	-
219	2	.198"	-
4RL	4	-	.062" x .400"

●●●● Material Options: B, C, F, N, O

2.36" x 3.37"
(59.9mm x 85.6mm)

Overall Tag Size

Five (5) Finished Tags

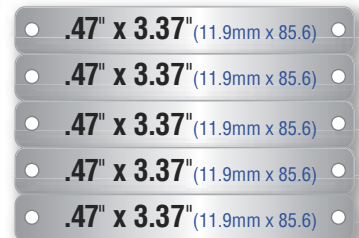

TAG

39

● Max. No. of Lines/Tag: 1 Max No. of Characters Per Line: 24

Order Code	# of Holes	Hole Size	Slot Size
000	0	-	-
115	1	.156"	-
215	2	.156"	-

●●● Material Options: O

NOTE: Characters Per Line are based on a 4mm Font Size.

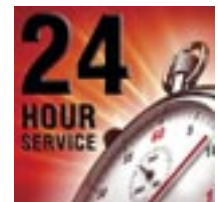

- - SmartTag™ 4500 & 2500 compatible
- - SmartTag™ 1100 compatible
- - HAY-40B compatible
- - MobileTag™ 600 compatible

See page 40 for Material Options description

Octagonal Tags

NOTE: Tags on this page are
NOT available for 24 Hour Embossing Service

For automatic round tag
embossing capability,
please call us.

TAG
43



Order Code	# of Holes	Hole Size	Slot Size
000	0	-	-
118	1	.188"	-

● Material Options: B,C,F,H,I,J,K,L,N,O,Q

TAG
44



Order Code	# of Holes	Hole Size	Slot Size
000	0	-	-
118	1	.188"	-

● Material Options: B,C,F,H,I,J,K,L,N,O,Q

ID Plates



Hayata Part No.	Length		Width		Thickness	
	In	mm	In	mm	In	mm
T-6334	2.48	63	1.33	34	0.010	0.26
T-8996	3.50	89	3.77	96	0.010	0.26
T-6008	2.36	60	0.31	8	0.010	0.26

● Material: Stainless Steel - uncoated



Hayata Part No.	Length		Width		Thickness	
	In	mm	In	mm	In	mm
T-8919B	3.50	89	0.75	19	0.15	0.38

● Material: Stainless Steel - uncoated

Round Tags

TAG
40



Order Code	# of Holes	Hole Size	Slot Size
000	0	-	-
112	1	.125"	-
125	1	.250"	-

●● Material Options: B,C,F,H,I,J,K,L,N,O,Q

TAG
41



Order Code	# of Holes/Slots	Hole Size	Slot Size
000	0	-	-
112	1	.125"	-
125	1	.250"	-

●● Material Options: B,C,F, H,I,J,K,L,N,O,Q

TAG
42



Order Code	# of Holes	Hole Size	Slot Size
000	0	-	-
112	1	.125"	-
125	1	.250"	-

●● Material Options: B,C,D,E,F,I,J,K,L,M,N,O,Q

For automatic round tag
embossing capability,
please call us.